

# **MAXXFAN MINI DELUXE INSTALLATION INSTRUCTIONS, INFORMATION AND OPERATING GUIDE FOR MODELS 3805, 3855, 3806, 3856, 3807, 3857**

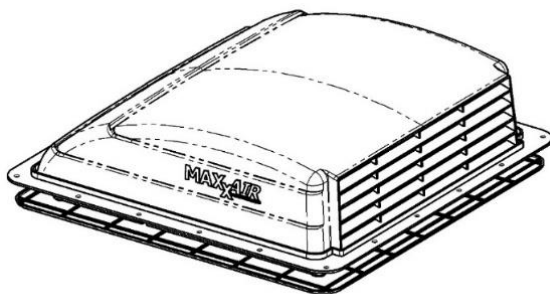

## **READ AND SAVE THESE INSTRUCTIONS**

**NOTE:** Refer to Installation Instructions, Information and Operation Guides regarding the model you have purchased.

The **MAXXFAN MINI Deluxe** installs into a standard RV roof opening of 14 by 14 inches.

To determine if your roof opening is correctly sized, simply remove the interior ceiling garnish trim ring of your existing roof vent and measure the ceiling opening or verify the opening is large enough by sliding the **MAXXFAN MINI Deluxe** sleeve into the opening.

The **MAXXFAN MINI Deluxe** is designed for a minimum roof thickness of 1 inch to a maximum of 6 inches.

The **MAXXFAN MINI Deluxe** requires a minimum 12 Volt DC, 2 amp service. Confirm that the circuit you intend to use will accommodate the additional load. Circuit must be fused and use appropriate gauge stranded wire for electrical connections.

### **WARNING! TO REDUCE THE RISK OF FIRE, ELECTRIC SHOCK, OR INJURY TO PERSONS, OBSERVE THE FOLLOWING:**

- a) Use this unit in the manner intended by AIRXCEL, INC. If you have questions, contact the manufacturer.
- b) Before servicing or cleaning unit, switch power off at service panel and lock the service disconnecting means to prevent power from being switched on accidentally. When the service disconnecting means cannot be locked, securely fasten a prominent warning device, such as a tag, to the service panel.

**CAUTION!** FOR GENERAL VENTILATION USE ONLY. DO NOT USE TO EXHAUST HAZARDOUS OR EXPLOSIVE MATERIALS AND VAPORS.

**This page intentionally left blank**

# INSTALLATION INSTRUCTIONS

## **WARNING! TO REDUCE THE RISK OF FIRE, ELECTRIC SHOCK, OR INJURY TO PERSONS, OBSERVE THE FOLLOWING:**

Installation work and electrical wiring must be done by qualified persons(s) in accordance with all applicable codes and standards, including fire-rated construction.

### STEP 1

**MAXXFAN MINI Deluxe VENTS** require a 14" x 14" roof opening. If you are replacing another type already installed, remove the old existing roof vent. Remove all old roof sealant for a minimum of 2" entirely around the roof opening.

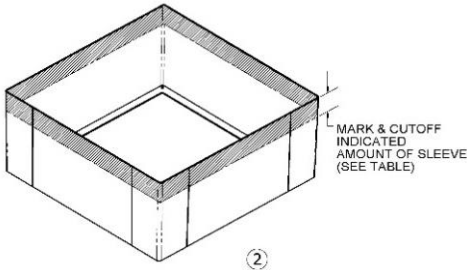

### STEP 2

Measure the thickness of the roof opening and, if necessary, mark and cut the height of the **MAXXFAN MINI Deluxe** sleeve per the following table. **NOTE:** for curved roofs measure the thickest part of the roof.

VEHICLE ROOF THICKNESS	CUT FROM MAXXAIR MINI VENT SLEEVE
4.0 – 4.5 inches	NONE (use full length sleeve)
3.5 – 4.0 inches	0.5 inches
3.0 – 3.5 inches	1.0 inches
2.5 – 3.0 inches	1.5 inches
2.0 – 2.5 inches	2.0 inches
1.5 – 2.0 inches	2.5 inches
1.0 – 1.5 inches	Not Applicable, Sleeve not used

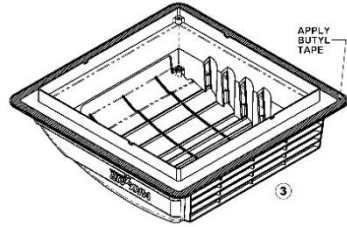

### STEP 3

Prior to installing the **MAXXFAN MINI Deluxe** hood portion over the roof opening, apply a continuous strip of BUTYL tape or equivalent to the underside of the flange in the area under the screw location dimples.

Attach the garnish sleeve using 4 screws provided in the hardware kit.

**CAUTION!** When installing your **MAXXFAN MINI Deluxe**, only use a caulking/sealant compatible with the flange (plastic product) and the roof surface. **DO NOT** use materials containing solvents such as or similar to Xylene, Toluene, Methyl Ethyl Ketone (MEK), Acetate or Acetone as they can damage the flange. Also, Polysulfide (Thiokol) type sealants must be avoided. If in doubt, please contact the manufacturer of your RV.

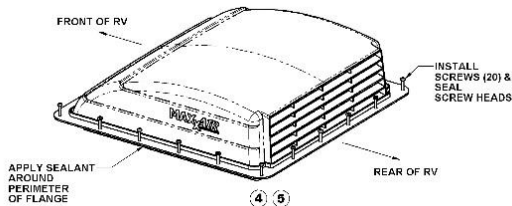

### STEP 4

Insert the **MAXXFAN MINI Deluxe** hood into the roof opening with the louvered section facing the rear of the vehicle and centering the hood in the opening. Using the twenty-eight (28) screws provided, attach the flange to the roof at each dimple location along the flange. Screw into the dimple to pierce the

flange, making sure not to overtighten the screws to avoid cracking the flange.

### STEP 5

After the **MAXXFAN MINI Deluxe** hood has been installed, remove the excess BUTYL caulk that may have squeezed out. Using a sealer such as Dicor self-leveling lap sealant or similar caulking, apply a daub over every exposed screw head. In addition, apply a bead (approximately 3/16" dia.) along the outside edge of the flange all the way around the vent.

### THIS COMPLETES THE ROOF TOP PORTION OF THE INSTALLATION

**CAUTION!** Disconnect main vehicle power before connecting 12 volt DC power to the **MAXXFAN MINI Deluxe!**

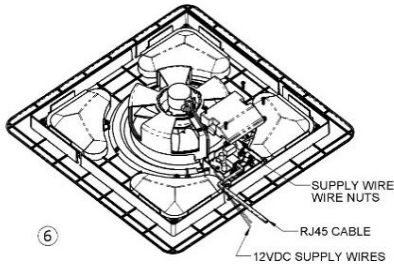

### STEP 6

Remove the 4 screws holding the plastic cover in place and insert the 12 volt DC power supply wires into the open hole in the side of the molded box on the **MAXXFAN MINI Deluxe**, allowing 4 to 6 inches of wire inside the molded box. Using the supplied wire nuts, connect the Positive (+) 12VDC supply wire to the **MAXXFAN MINI Deluxe** marked "POS 12VDC" and the Negative (-) 12VDC supply wire to the **MAXXFAN MINI Deluxe** wire marked "Neg. 12VDC". Insert the RJ45 cable plug into the connector on the PC Board. Secure the wires in the box by reinstalling the lid ensuring the wires are routed through the built-in strain relief section of the box.

**Rotary Switch Models:** Using the supplied wire nuts, connect the Positive (+) 12VDC supply wire to the **MAXXFAN MINI Deluxe** marked "POS 12VDC" and the Negative (-) 12VDC supply wire to the **MAXXFAN MINI Deluxe** wire marked "Neg. 12VDC".

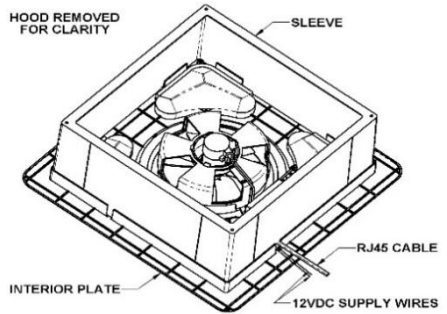

### STEP 7

Route supply wires and RJ45 cable to notch in the back of the **MAXXFAN MINI Deluxe** interior plate, place sleeve over interior plate with supply wires routed through hole formed between interior plate and sleeve. RJ45 cable can be routed through any side of the **MAXXFAN MINI Deluxe** as needed.

**Rotary Switch Models:** Route supply wires through notch in the back of the **MAXXFAN MINI Deluxe** interior plate. Place sleeve over interior plate with supply wires routed through hole formed between interior plate and sleeve.

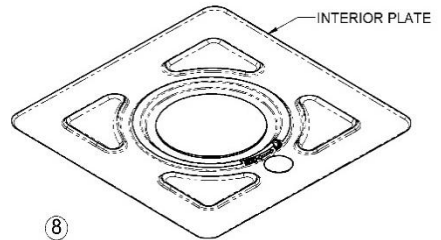

### STEP 8

Raise the interior plate to the ceiling ensuring that the flange on the interior plate meshes with the roof top flange. Press up on the interior plate until it is tight to the ceiling.

**Rotary Switch Models: This complete the installation of the MAXXFAN MINI Deluxe**

### STEP 9

Select a convenient location for the wall control, keeping in mind the wall control with the motion sensor will turn on the light when it senses movement.

## Step 10

Installing the Wall Control:

Place mounting screw template against the wall where wall control will be mounted.

Using supplied screws, mount the template to the wall.

Remove plastic from between mounting screws.

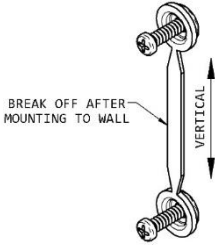

Insert the RJ45 connector into the back of the wall control. Place wall control on mounting screws and gently push the wall control down to lock the

wall control onto mounting screws.

## STEP 11

Reconnect main vehicle power to the MAXXFAN MINI Deluxe.

**THIS COMPLETES THE INSTALLATION OF YOUR MAXXFAN MINI Deluxe with Wall Control**

## OPERATION OF YOUR MAXXFAN MINI Deluxe

Operation of your **MAXXFAN MINI Deluxe** simply entails rotating the rotary switch (if equipped) or pushing the ON/OFF button on the wall control to activate the exhaust fan or optionally: the LED lighting or the motion sensor. Open the air baffle in the interior plate to allow maximum airflow. Close baffle to impede infiltration of air when exhaust fan is not in use.

### USER INSTRUCTIONS SERVICING

Cleaning of your **MAXXFAN MINI Deluxe** may be achieved with mild soap and water only. Before removing the screen for cleaning, ensure the fan is turned to the OFF position. **CAUTION: Do not operate the fan with the screen removed.**

Should you have questions, please contact AIRXCEL / MAXXAIR VENTILATION SOLUTIONS Customer Service at 316.832.4357.

For **WARRANTY** information, please visit [www.airxcel.com/maxxair](http://www.airxcel.com/maxxair).

**OPERATION OF THE 3853 WALL CONTROL (Shown Below)**

<b>FAN ON/OFF</b>	Turns the fan motor ON or OFF
<b>LIGHT ON/OFF</b>	Turns the light ON or OFF



**OPERATION OF THE 3854 WALL CONTROL (Shown Below)**

<b>FAN</b>	Turns the fan motor on or off
<b>LIGHT</b>	Turns the light on or off
<b>MOTION</b>	Turns the motion sensor option on or off Note: The green light on the wall control indicates the motion sensor is activated. When the motion sensor is activated, the light will turn on when motion is sensed. The light will turn off after 20 seconds if there is no movement detected.



**This page intentionally left blank**

PLACE CONSUMER LABEL HERE



**For additional product information please visit [www.AIRXCEL.com](http://www.AIRXCEL.com)**  
AIRCEL, INC. – RV Products Division / MAXXAIR  
3050 N. St. Francis St. • Wichita, KS 67219 • 316.832.3400